

- Circular recessed LED downlight
- Aluminium body machined from solid in 6082 alloy with surface protection treatment and subsequent polyester powder paint resistant to corrosion, atmospheric conditions and salt spray
- Brushed stainless steel frame AISI 316L
- Thermal shock resistant tempered, extraclear, anti-glare safety glass with grinded edges
- Plastic cable gland resistant to corrosion, atmospheric conditions and salt spray
- Springs for ceiling installation
- IP67 external power supply included
- IP68 connector for the connection between projector and power supply included
- Maximum permissible ambient temperature + 35°C

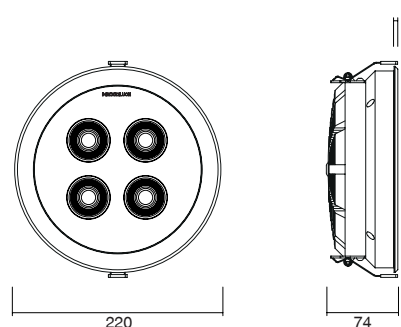

- *Proiettore LED da incasso circolare*
- *Corpo in alluminio tornito dal pieno lega 6082 con trattamento superficiale di protezione e successiva verniciatura in polvere di poliestere resistente agli agenti atmosferici, alla corrosione ed alle nebbie saline*
- *Cornice esterna in acciaio inox AISI 316L spazzolata*
- *Vetro di sicurezza temperato con bordi molati, extrachiaro ed antiriflesso resistente agli shock termici*
- *Pressacavo in plastica resistente agli agenti atmosferici, alla corrosione ed alle nebbie saline*
- *Molle per installazione a soffitto*
- *Alimentatore esterno IP67 incluso*
- *Connettore IP68 per la connessione fra proiettore ed alimentatore incluso*
- *Temperatura ambiente massima ammissibile +35°C*



Lamp / Lampada 4 LED COB CREE	Input / Alimentazione 220/240V 50/60Hz	Power / Potenza 50 / 75 / 100W	Color Tolerance/ Tolleranza Cromatica 2-SDCM / 3-SDCM	CRI / CRI 80 MIN
-------------------------------------	--	--------------------------------------	---	------------------------



NEXO LUCE (Factory)  
Strada Mirabella, 10  
46040 Cavriana (MN), ITALY  
T +39 0376 771513 F +39 0376 772235  
sales@nexoluce.com www.nexoluce.com

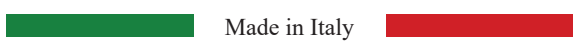

© Nexo Luce, a company incorporated in Italy. The logo and the name are the property of Nexo Luce SRL. The present datasheet and its content in whole or in part are the property of Nexo Luce SRL. All rights reserved. We reserve the right to change details and specifications without prior written notice.

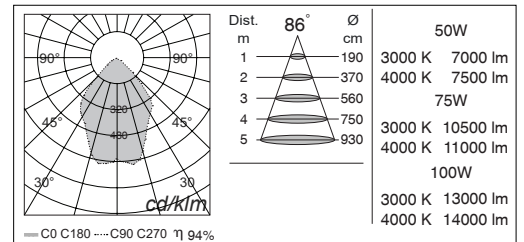
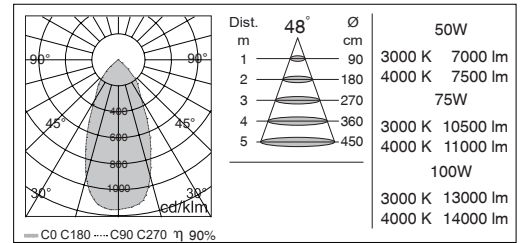
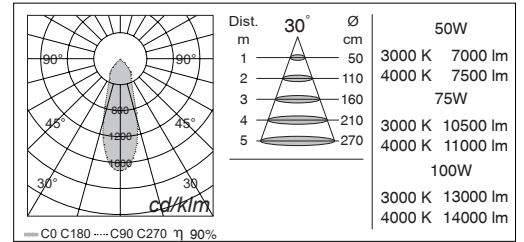
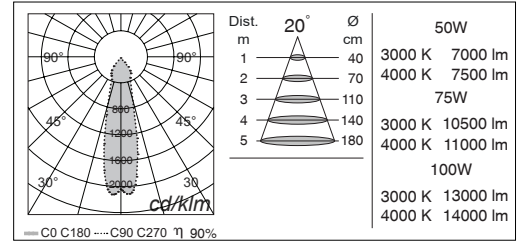
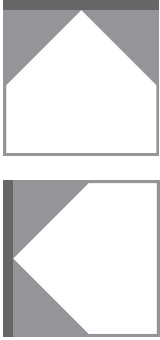

MAIN CODE CODICE BASE	RELEASE EDIZIONE	LIGHT COLOR COLORE LUCE	WATT WATT	OPTIC OTTICA	CONTROLLO CONTROL	FRAME COLOR COLORE
<b>2487</b>	<b>.1</b>	<b>B</b> 3000K	<b>.50</b> 50W	<b>.D</b> 20°	<b>1</b> ON/OFF	<b>.G</b> STAIN. STEEL / INOX
		<b>C</b> 4000K	<b>.75</b> 75W	<b>.F</b> 30°		
		* others on request / altri su richiesta	<b>100</b> 100W	<b>.I</b> 48°		
				<b>BZ</b> 86°		

CODE EXAMPLE : Projector with warm white light color at 3000K, 50W, 20° optic, ON/OFF control, frame stainless steel color  
2487.1B.50.D1.G

ESEMPIO DI CODIFICA : Proiettore con luce calda a 3000K, 50W, ottica 20°, controllo ON/OFF, colore in acciaio inox  
2487.1B.50.D1.G

NEXO LUCE (Factory)  
Strada Mirabella, 10  
46040 Cavriana (MN), ITALY  
T +39 0376 771513 F +39 0376 772235  
sales@nexoluce.com www.nexoluce.com

Made in Italy