

- Track mounted LED projector
- Aluminium body machined from solid in 6082 alloy with polyester powder paint resistant to corrosion
- Tempered, extraclear, anti-glare safety glass with grinded edges
- Beam angles 20° 30° 48° 86°
- Adjustable pan and tilt movements
- Power supply integrated in the track adapter
- Compatible with three-phase Eurostandard tracks
- Maximum permissible ambient temperature + 35°C

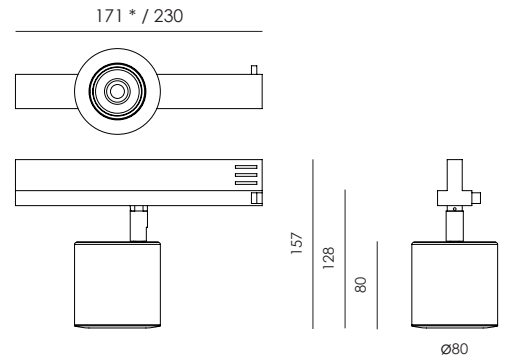

- *Proiettore LED a binario*
- *Corpo in alluminio tornito dal pieno lega 6082 con verniciatura in polvere di poliestere resistente alla corrosione*
- *Vetro di sicurezza temperato con bordi molati, extrachiaro ed antiriflesso*
- *Angoli del fascio 20° 30° 48° 86°*
- *Orientabile in senso orizzontale e verticale*
- *Alimentatore integrato nell'adattatore per binario*
- *Compatibile con binari Eurostandard trifase*
- *Temperatura ambiente massima ammissibile +35°C*



Lamp / Lampada	Input / Alimentazione	Power / Potenza	Color Tolerance/ Tolleranza Cromatica	CRI / CRI
1 LED COB CREE	220/240V 50/60Hz	10 / 14 / 19 / 25W	2-SDCM / 3-SDCM	80 MIN

* only for 10W power version / solo per versione con potenza 10W



NEXO LUCE (Factory)
Strada Mirabella, 10
46040 Cavriana (MN), ITALY
T +39 0376 771513 F +39 0376 772235
sales@nexoluce.com www.nexoluce.com

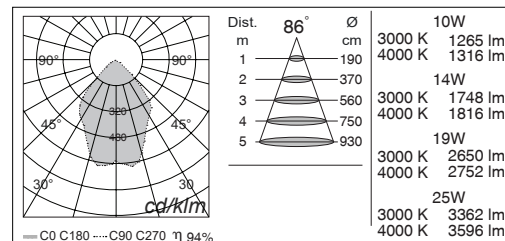
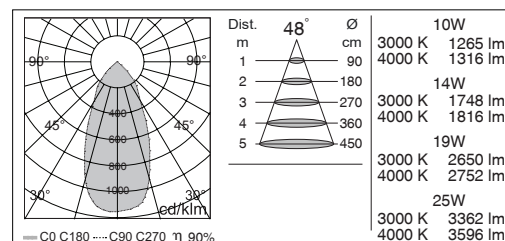
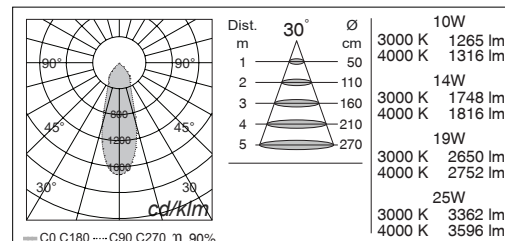
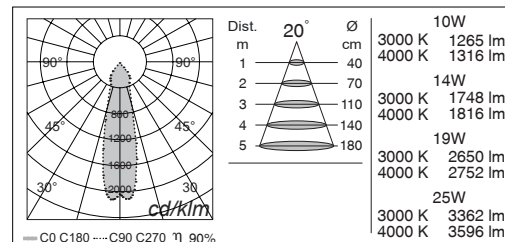
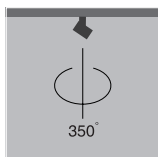
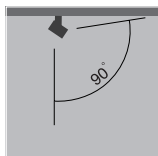
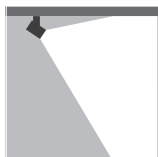

MAIN CODE CODICE BASE	RELEASE EDIZIONE	LIGHT COLOR COLORE LUCE	WATT WATT	OPTIC OTTICA	CONTROL CONTROLLO	FRAME COLOR COLORE
2648	.1	B 3000K	.10 10W	.D 20°	1 ON/OFF	BS WHITE / BIANCO
		C 4000K	.14 14W	.F 30°		BT BLACK/ NERO
		* others on request / altri su richiesta	.19 19W	.I 48°		
			.25 25W	BZ 86°		

CODE EXAMPLE : Projector with warm white light color at 3000K, 10W, 20° optic, ON/OFF control, white color
2648.1B.10.D1BS

ESEMPIO DI CODIFICA : Proiettore con luce calda a 3000K, 10W, ottica 20°, controllo ON/OFF, colore bianco
2648.1B.10.D1BS

NEXO LUCE (Factory)
Strada Mirabella, 10
46040 Cavriana (MN), ITALY
T +39 0376 771513 F +39 0376 772235
sales@nexoluce.com www.nexoluce.com